

ARQIS106i

CABINET LOUDSPEAKERS

Architectural Loudspeaker Cabinet



PRODUCT OVERVIEW

ARQIS106i is a 2-way wooden loudspeaker cabinet with a compact format, stylish aesthetics, excellent sound quality and long-term reliability, featuring 120 WRMS @ 8Ω, 6" woofer and 1" HF Compression Driver. Its VEASY wall bracket included (VESA compatible), allows for pan & tilt adjustment, employing a single screw for fastening. It has been specifically designed to fulfil permanent installation requirements where a perfect balance between sound performance and architectural/interior's design matching is a must.

KEY FEATURES

- Full range, 2-way architectural loudspeaker
- 120 WRMS @ 8Ω
- 6" low frequency woofer
- 1" high frequency compression driver (rotatable)
- Double INPUT/STACK connector, Euroblock type, with security attachment screws to avoid accidental disconnection
- VEASY Wall bracket included, allowing for pan & tilt adjustment, employing a single screw for fastening. Robust, quick and easy to install, including jumps and markings for repeating speaker orientation.
- Metal safety sling included, to avoid drops in case of accidental detachment from the wall surface
- Available in black (RAL 9005) and white (RAL 9003) colour
- [Ecler Loudspeakers EQ Settings available.](#)
- [EASE files available](#)



APPLICATIONS

- Commercial
- Corporate
- Hotels and restaurants
- Education
- Sports and wellness
- Leisure

TECHNICAL SPECIFICATIONS

ARQIS106i	
System	
Effective frequency range ¹	75 Hz - 20 kHz
Coverage angle ²	140°x160° (HxV)
Power handling	120W RMS / 480W Peak
Sensitivity ³	88dB (1W/1m)
Maximum SPL ⁴	109dB continuous / 115dB peak
Recommended amplifier	240W
Transducers	
Ways	2-way, full range
Low frequency driver	6" woofer
High frequency driver	1" Compression driver (rotatable)
Nominal impedance	8Ω
Filters	
Crossover filter	3,2 kHz
Recommended High-Pass protection filter	70 Hz with minimum 12 dB / octave filter
Physical	
Connection type	2 x Euroblock
Installation options	Surface, wall, desktop
Environmental	IP31
Enclosure material	MDF
Grille material	Steel
Grille fixing system	Screw fixation
Flying points	8 x M6
Operating temperature	Min: -10°C ; 14°F Max: 40°C ; 104°F
Operating humidity	<85% HR
Storage temperature	Min: -10°C ; 14°F Max: 40°C ; 104°F
Storage humidity	<90% HR
Included accessories	VEASY Wall Bracket / 3mm Allen key/ 4mm Allen key / 6mm Allen key
Finished color	Black (RAL9005) or White (RAL 9003)
Dimensions (WxHxD)	215 x 350 x 240 mm / 8.54 x 13.78 x 9.45 in
Weight	7,4 kg / 16.31 lb
Pieces per box	1 unit
Shipping dimensions (WxHxD)	395 x 290 x 405 mm / 15.55 x 11.42 x 15.94 in
Shipping weight	8.7 Kg / 19.18 lb

¹10dB below the sound pressure level at specified sensitivity

²6dB below the sound pressure level than that at the direction of maximum level, Max. angle between 1 kHz and 4 kHz.

³Measured on-axis, far field and referenced to 1 meter by inverse square law. Average from 100 Hz to 10 kHz.

⁴Calculated from sensitivity and power handling specifications, exclusive of power compression

FREQUENCY RESPONSE ON-AXIS

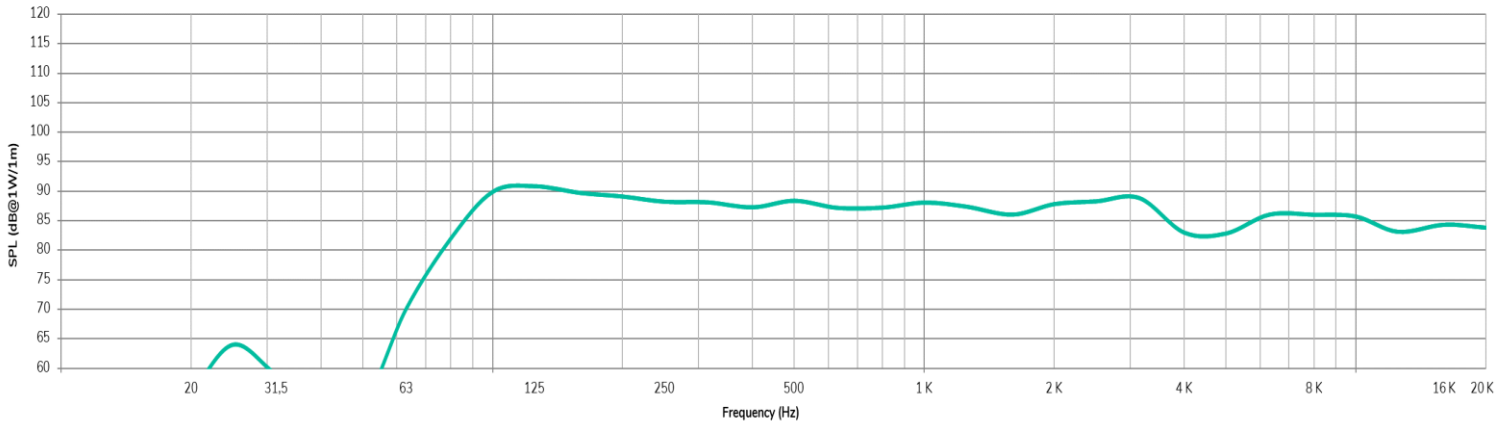

MECHANICAL DIAGRAMS



Ecler ARQIS106i Mechanical Diagram

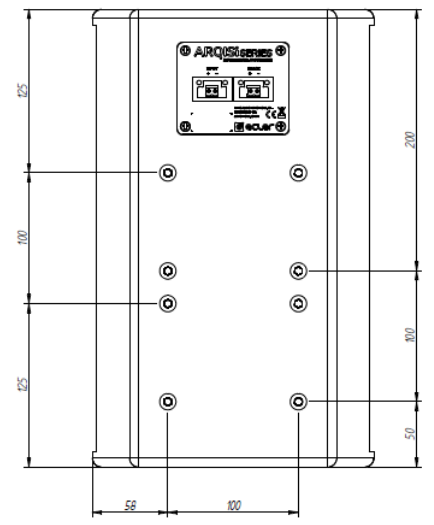
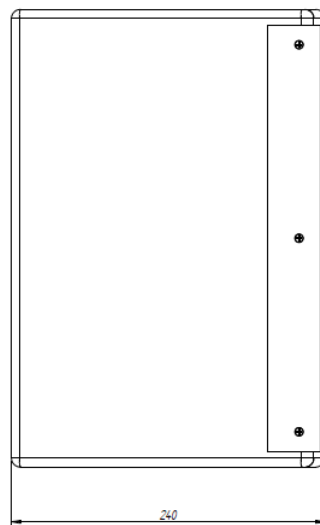
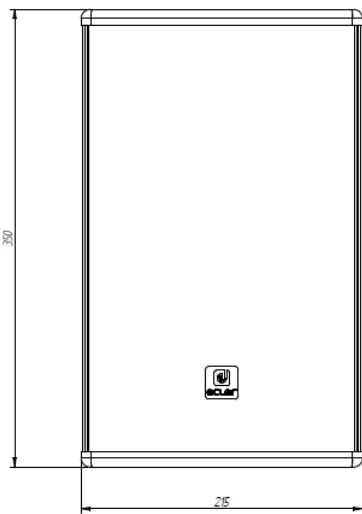
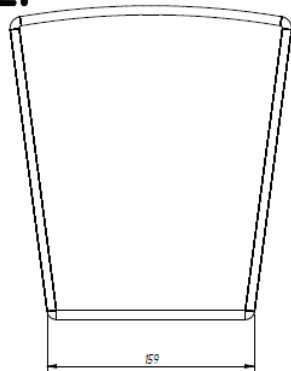

All the measurements are in mm

61-1092-0100

www.ecler.com

POLAR DIAGRAMS

HORIZONTAL

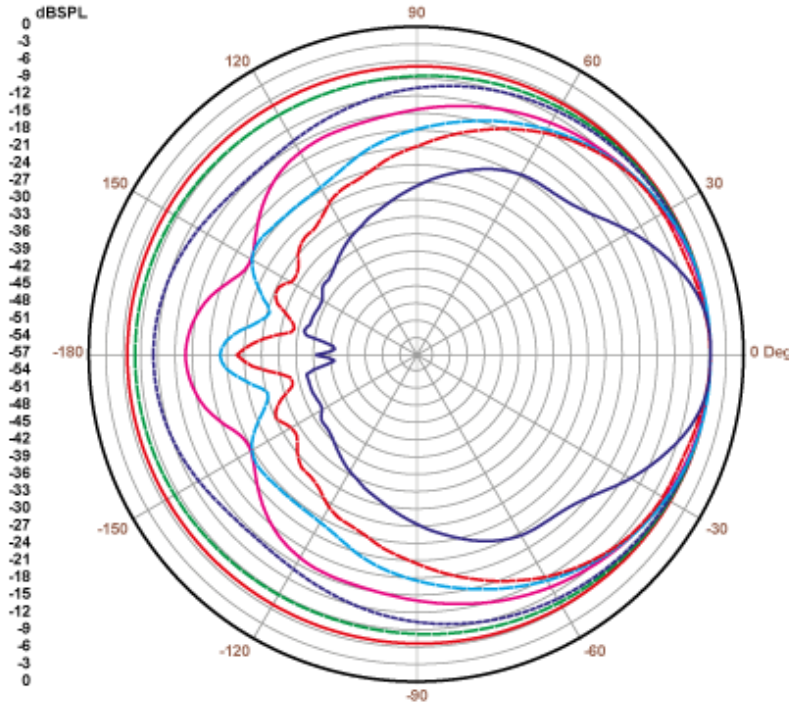

Curve	Freq	BW	Q	DI
—	125.00	360	1.0	0.0
—	250.00	360	1.0	0.0
—	500.00	203	1.8	2.5
—	1.00K	143	2.5	4.0
—	2.00K	119	3.0	4.8
—	4.00K	115	3.1	5.0
—	8.00K	60	7.2	8.6

VERTICAL

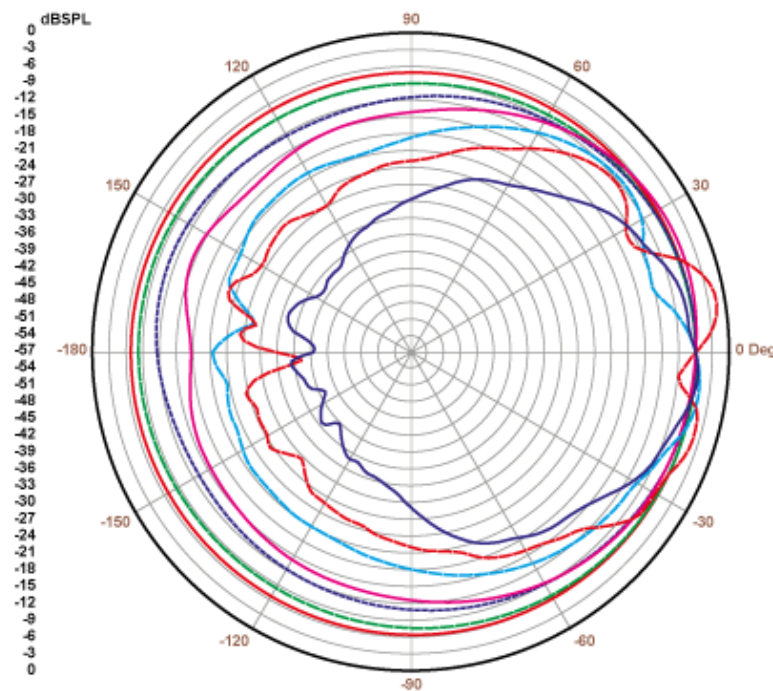

Curve	Freq	BW	Q	DI
—	125.00	360	1.0	0.0
—	250.00	360	1.0	0.0
—	500.00	215	1.7	2.2
—	1.00K	159	2.3	3.6
—	2.00K	58	6.2	7.9
—	4.00K	70	5.1	7.1
—	8.00K	58	6.2	7.9

A&E SPECIFICATIONS

The loudspeaker shall be a 2-way wooden loudspeaker cabinet, incorporating a high-efficiency 6" mid/low woofer and 1" rotatable compression driver. It shall have a power handling of 120 W RMS with a peak power handling of 480 W and the effective frequency range (± 10 dB) shall be from 75 Hz to 20 kHz.

Crossover filter shall be at 3,2 kHz. The sensitivity shall be 88 dB when measuring with an input signal of 1 Watt at a distance of 1 meter, while the maximum continuous sound pressure level shall be 109 dB.

The coverage angle shall be $140^\circ \times 160^\circ$. The loudspeaker shall have a nominal impedance of 8 Ω . It shall have an enclosure constructed out of medium density wood with a textured and scratch resistant paintwork finish. The front finishing shall be made with an overlapping front grill with a rotatable logo, giving a slim and elegant impression.

It shall include a double INPUT/STACK connector, Euroblock type, with security attachment screws to avoid accidental disconnection. It shall include a VESA compatible wall bracket, which enables pan & tilt adjustment, employing a single screw for fastening. An additional metal safety sling shall be provided, to avoid drops in case of accidental detachment.

The full range system's enclosure shall be 217 mm wide, 350 mm high and 240 mm deep and the weight shall not exceed 7,4 Kg.

The loudspeaker shall be the ECLER ARQIS106i.



All product characteristics are subject to variation due to production tolerances. **NEEC AUDIO BARCELONA S.L.** reserves the right to make changes or improvements in the design or manufacturing that may affect these product specifications

For technical queries contact your supplier, distributor or complete the contact form on our website, in [Support / Technical requests](#).

Motors, 166-168 08038 Barcelona - Spain - (+34) 932238403 | information@ecler.com | www.ecler.com